

Magnetic Field Sensors
BMF 305K-PS-C-2-S49-00,5
33,5x10,5x6,5
Short circuit protection

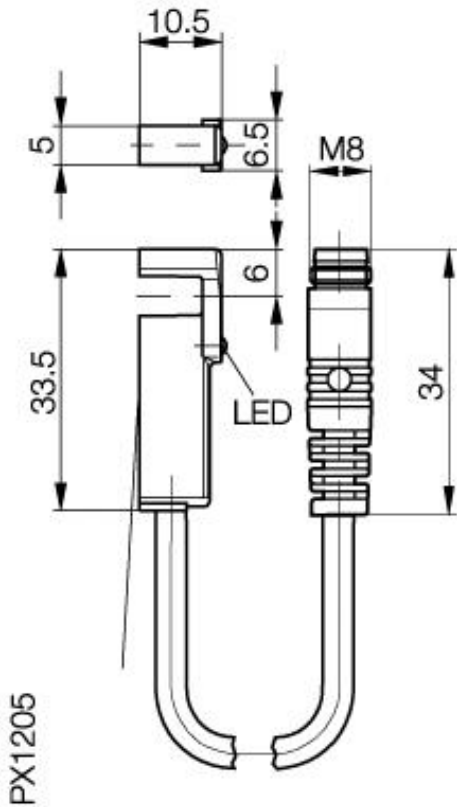

Common Data

Rated operating field strength	1,2kA/m
Assured operating field strength	2kA/m
Repeatability R	1,0% v. Hn
Hysteresis	45% v. Hn
Function indication	yes
Ambient temperature range	-25...+70°C
Temp.Drift from Switch. Pnt	0,3%/°C v. Hn

Mechanical Data

Measurements BxHxT oder DxT	33,5x10,5x6,5mm
Housing material	LCP
Material of sensing face	PU
Degree of protection	IP67IP
Connection	Connector S49 (M8 3-pin)

Electrical Data

Current type	DC
Wiring	3-Wire
switching function	normally-open
Output signal	PNP
Rated operational voltage	24 DCV
Rated operational current	200 (150/70°C)mA
Supply voltage	10...30V
Ripple	≤ 15% v. Ub
Rated supply frequency	DCHz
No-load supply current	≤30/≤10mA
Off-state current	≤ 80µA
Maximum operational current	200mA
Voltage drop	≤ 2,5V
Switch-On-Delay	0,05ms
Switch-Off-Delay	0,05ms
Short circuit protection	yes
Protected against polarity reversal	yes

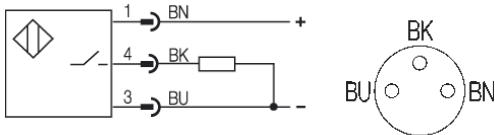

Datasheet number:

Definitions see general catalog.
 If not otherwise noted, ratings according to
 IEC 60947-5-2 (DIN EN60947-5-2)

Balluff GmbH
 Schurwaldstrasse 9
 73765 Neuhausen a.d.F.
 Phone (07158) 173-0 Fax (07158) 5010

Datenblatt by CD-ROM - 04/2007

BALLUFF
 sensors worldwide